



- Up to 1200W in <1U chassis
- Low acoustic noise
- Efficiency up to 90%
- 1.5V to 58V standard output voltages
- All outputs fully floating
- Series / Parallel of Multiple outputs
- 19" Rack-Mount Version Available
- Approved to UL/EN60601-1 3rd Edition



POWER SUPPLY DESIGN EXCELLENCE

The Medistax® low noise family of configurable power supplies provides up to 1200W in an extremely compact 1U package. These units are ideally suited to solving complex power system requirements where a full custom design is not an option. The fully floating outputs can be combined in series or parallel (or series-parallel) to achieve virtually any output combination you can imagine.

The Medistax® low noise family comprises 6 different chassis ranging from 200W to 1200W and a total of 7 output module types giving you almost infinite possibilities to configure the outputs you need. Output voltages may be set manually via a potentiometer or dynamically using the various control inputs.

A bias supply is included to power areas of your circuit needing to be kept on at all times.

The architecture is based upon low loss technologies, thus reducing thermal build-up in your system and providing market leading power densities up to 14W/in³ and efficiencies up to 90%.

Each Medistax® chassis is a fully functioning power supply, Multiple supplies can be combined into a 1U 19" rack to produce complex system-level power – in a very short time-scale.

The system is fully UL/EN60601-1 3rd Edition approved and is CE marked to the Low Voltage Directive – meaning that any custom combination immediately carries these approvals.

Medistax® - low noise

CHASSIS NUMBER	MODULE SLOTS	OUTPUT POWER	MAX. INPUT CURRENT ¹	INPUT FUSE ²	DIMENSIONS mm (inches)	CASE
MM1U-4L	4	200W	4.5A @ 200W	5A	89w x 40.4h x 269.8l (3.5w x 1.6h x 10.6l)	A
MM1U-4M	4	400W	5.5A @ 400W	6.3A	89w x 40.4h x 269.8l (3.5w x 1.6h x 10.6l)	A
MM1U-4O	4	600W	7.5A @ 400W	8A	89w x 40.4h x 269.8l (3.5w x 1.6h x 10.6l)	A
MM1U-6L	6	600W	7.5A @ 400W	8A	127w x 40.4h x 269.8l (5.0w x 1.6h x 10.6l)	C
MM1U-6M	6	900W	11.5A @ 600W	12A	127w x 40.4h x 269.8l (5.0w x 1.6h x 10.6l)	C
MM1U-6O	6	1200W	11.5A @ 850W	12A	127w x 40.4h x 269.8l (5.0w x 1.6h x 10.6l)	C

NOTES: 1. At 85VAC input.
2. 250V HRC, 5 x 20mm.

OTHER Medistax® PRODUCTS
Medistax® Low Noise
Medistax® Ultra Quiet
Medistax® Industrial



GENERAL SPECIFICATIONS

INPUT SPECIFICATIONS	
Input Voltage Range	85-264VAC single phase / 120-380VDC
Input Frequency Range	47-63Hz / DC (consult factory for 440Hz)
Input Current	see model table
Inrush Current @ 230VAC, 25°C	4-slot - 50A, 6-slot - 25A
Under Voltage Lockout	65-74V (shut-down)
Leakage Current @250VAC, 60Hz, 25°C	<300µA (150µA optional)

ENVIRONMENTAL SPECIFICATIONS	
Temperature Range	-20° to +70°C operating, -40°C to +85°C storage
Derating	see graphs
Humidity	5-95%RH, non-condensing
Cooling	4-slot - single internal fan, 6-slot - two internal fans
Acoustic Noise, measured at 1m	4-slot - 39.8dBA, 6-slot - 42.7dBA
Vibration, 1.5G	10-200Hz
Reliability @25°C, full load	chassis - 0.92fpmh (excluding fans, module -0.98fpmh)

SAFETY & EMC SPECIFICATIONS		
Safety Standards	EN60601-1, UL60601-1, CSA22.2 No.60601-1 3rd Edition (UL file no. E223749)	
Isolation	1500VAC input - chassis 4000VAC input - output 500VAC output - output / output - chassis	
Emissions (Conducted & Radiated)	Conducted	EN55011, EN55022, FCC - Level B
	Radiated	EN55011, EN55022, FCC - Level B
	Harmonic Distortion	EN61000-3-2 Class A Compliant
	Flicker & Fluctuation	EN61000-3-3 Compliant
Immunity	ESD	EN61000-4-2 Level 2
	Radiated	EN61000-4-3 Level 3
	Fast Transients - Burst	EN61000-4-4 Level 3
	Input Line Surges	EN61000-4-5 Level 3
	Conducted	EN61000-4-6 Level 3
	Voltage Dips	EN61000-4-11 Compliant

BIAS OUTPUT, SIGNALS & CONTROLS	
Bias Supply Voltage, Tolerance	5VDC, 4.8-5.2VDC
Bias Supply Current	250mA max. (500mA available to special order, please call.)
AC Fail	>5mS warning, optical isolated 4mA sink current
Inhibit ¹	contact closure inhibits all module outputs and fans
Enable ¹	contact closure enables all module outputs and fans

1. bias supply remains on whenever input supply is present.

Medistax® - low noise



AVAILABLE MODULES & OUTPUT SPECIFICATIONS

MODULE NUMBER	Vmin (trim)	Vmin (pot)	Vnom	Vmax	I _{max}	POWER
Mx1	1.0V	1.5V	2.5V	3.6V	50A	125W
Mx2	1.5V	3.2V	5.0V	6.0V	40A	200W
Mx3	4.0V	6.0V	12.0V	15.0V	20A	240W
Mx4	8.0V	12.0V	24.0V	30.0V	10A	240W
Mx5	8.0V	24.0V	48.0V	58.0V	6A	288W
Mx7	-	5.0V	24.0V	28.0V	5A	120W
Mx8	-	V1 - 5.0V V2 - 5.0V	V1 - 24.0V V2 - 24.0V	V1 - 28.0V V2 - 28.0V	V1 - 3A V2 - 3A	V1 - 72W V2 - 72W

Medistax® - low noise

OUTPUT SPECIFICATIONS	
Output Power	see model table
Output Voltage(s)	dependent on installed modules (see separate module datasheet)
Minimum Load	0A
Line Regulation	±0.1% for ±10% change in input from nominal
Load Regulation	±0.2% for 25% to 75% load change
Cross Regulation	±0.2%
Ripple & Noise, 20MHz bandwidth	100mV or 1.0% pk-pk
Overvoltage Protection	Vset Tracking - 110%, Vmax Latching - 125%
Overcurrent Protection	Straight line with hiccup activation at <30% of Vnom - 110/120%
Remote Sense Compensation	0.5VDC max. (except Mx7 & Mx8)
Overshoot	<2%
Turn On Delay	AC ON - <600mS, Enable ON - 30mS
Rise Time, monotonic	<5mS
Hold Up Time	Full Load - 20mS
Efficiency @ 230VAC, 750W/24V	4-slot - 89%, 6-slot - 90%

MODULE CONNECTIONS

Mx1 - Mx7

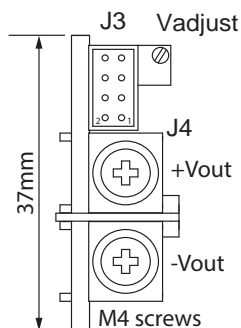

Module	J3 Pin Function	
Mx1 to Mx5	1: +Sense 3: Vtrim 5: +Inh/En 7: +PG	2: -Sense 4: Itrim 6: -Inh/En 8: -PG
Mx7	1: - 3: - 5: -PG 7: Inh	2: - 4: Com 6: +PG 8: Com

J3 Mating Connector

Housing:
Molex 51110-0860 - Locking
Molex 51110-0850 - Non Locking
Crimp Terminal: Molex 50394

Mx8

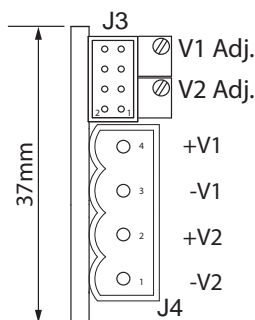

Module	J3 Pin Function	
Mx8	1: -PG V2 3: Inh V2 5: -PG V1 7: Inh V1	2: +PG V2 4: Com V2 6: +PG V1 8: Com V1

J3 Mating Connector

Housing:
Molex 51110-0860 - Locking
Molex 51110-0850 - Non Locking
Crimp Terminal: Molex 50394

J4 Mating Connector

Camden 9200/4A



MODULE DERATING

The output rating of Medistax® modules is dependent on two factors, location within the chassis and ambient temperature according to the table and derating curves below. For correct application the resultant derating should be applied to each affected module before applying the overall chassis derating shown later in this datasheet.

CHASSIS	Slot	Mx1	Mx2	Mx3	Mx4	Mx5	Mx7	Mx8
4-slot	A	2	2	2	1	1	1	1
	B	2*	2*	2	1	1	1	1
	C	2	2	1	1	1	1	1
	D	1	1	1	1	1	1	1
6-slot	A	1	2	1	1	1	1	1
	B	2*	2*	1	1	1	2	2
	C	2	1	1	1	1	1	1
	D	1	1	1	1	1	1	1
	E	1	1	1	1	1	1	1
	F	1	1	1	1	1	1	1

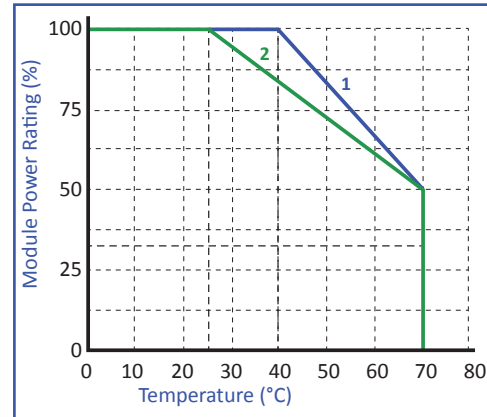

* Module can deliver 95% of rated power at 25°C ambient.

Medistax® - low noise

MODULE POWER LIMITING

Medistax® modules have a several of levels of protection to ensure that power supply is not damaged if used under overload conditions. When the output voltage setting (Vset) is less than or equal to the nominal setting (Vnom), the current limiting is at the current limit set point. However if Vset is greater than Vnom, the output power is limited to ensure that the module does not exceed its power rating.

For example, Mx4 is adjustable between 12V and 30V. I_{max} is 10A. Power rating is 240W. At 24V the module can deliver 10A continuously, i.e. 240W. At 30V, the module can still deliver 240W, 8A continuous.

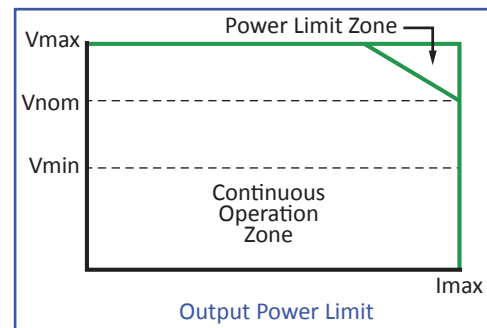

MODULE CURRENT LIMIT PROGRAMMING

A variety of over current protection methods are possible with the Medistax® modules. Modules type Mx1 to Mx5 can be programmed for Straight-line current limiting or Foldback current limiting while Mx7 employs only Straight-line current limiting. Simple external application circuits may be used to achieve programmable foldback current and user programmable reduced current limit levels. See the Medistax® Designers Manual for full details.

The default current limit characteristic is Straight Line Current Limiting.

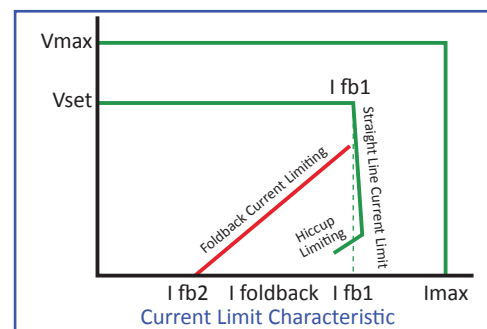



Voltage Adjustment - Local

The Medi-turn potentiometer that adjusts each output within the specified range may be accessed via the output panel of the power supply. Clockwise rotation increases output voltage. Resolution is approximately 5% of nominal voltage (Vnom) per turn.

Voltage Adjustment - Remote (resistive / electronic)

The output voltage may be adjusted or trimmed by means of an external resistor or potentiometer network connected to the Vtrim pin on the J3 connector on the module. Linear Electronic programming is also possible and may be implemented according to the formula $V_{out} = K V_{control}$. See Powerstax MM1U series Designers' Manual for full details.

Parallel Operation

To achieve increased current capacity, simply parallel outputs using the standard parallel links. Powerstax 'wireless' sharing ensures that current hogging is not possible.

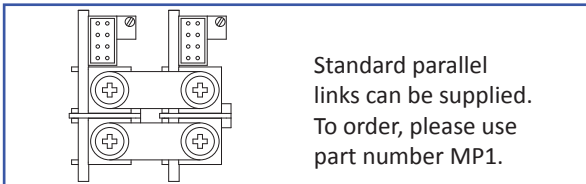

Standard parallel links can be supplied. To order, please use part number MP1.

Serial Operation

To achieve increased output voltages, simply series outputs using standard series links, paying attention to the requirements to maintain SELV levels if required in your system.

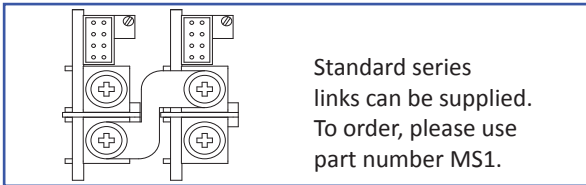

Standard series links can be supplied. To order, please use part number MS1.

Remote Sensing

When the load is remote from the power supply, the remote sense pins may be used to compensate for drops in the power leads. Where the power cabling contributes significant dynamic impedance, see MM1U series Designers' Manual.

Current Limit Adjustment

The output current limit setting may be adjusted (downwards only) by means of an external resistor connection to the Itrim pin on the J3 connector on the module.

Bias Voltage (Located in chassis)

A SELV isolated 5V (always on) bias voltage rated at 500mA (30mA MS1U-6E & MM1U-6E) is provided on J2 to facilitate miscellaneous control functions.

Inhibit/Enable

Inhibiting may be implemented either globally or on a per module basis (Power Unit or Power Module inhibiting). Reverse logic (Enabling) may also be implemented, see MM1U series Designers' Manual.

AC Fail

Open collector signal indicating that the input voltage has failed or is less than 80Vac. This signal changes state giving 5mS of warning before loss of output regulation. See MM1U series Designers' Manual for full specifications.

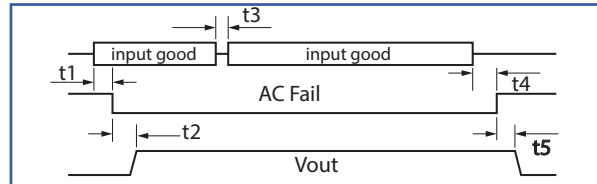

Temperature Alarm (Option 1)

Open collector signal indicating excessive power unit temperatures due to fan failure or operation beyond ratings. This signal is activated at least 10ms prior to system shut-down.

Fan Fail (Option 1)

Open collector signal indicating that at least one of the system fans have failed. This does not cause system shut-down.

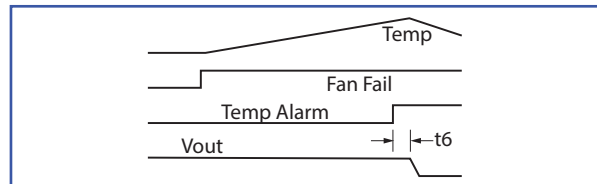

Power Good

Opto-isolated output signal indicates that the power module is operating correctly and output voltage is within normal band. Opto transistor ON = Good.

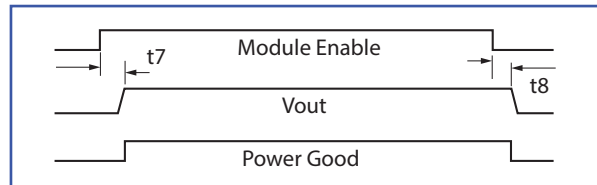

Indication LEDs

Each Power Module has a visual indicator to identify that it is operating within normal ratings. Very useful for system diagnosis.

Connecting to Capacitive Loads

When connecting Medistax® units to capacitive loads external blocking diodes of appropriate current capacity must be used.



MECHANICALS - 4-SLOT

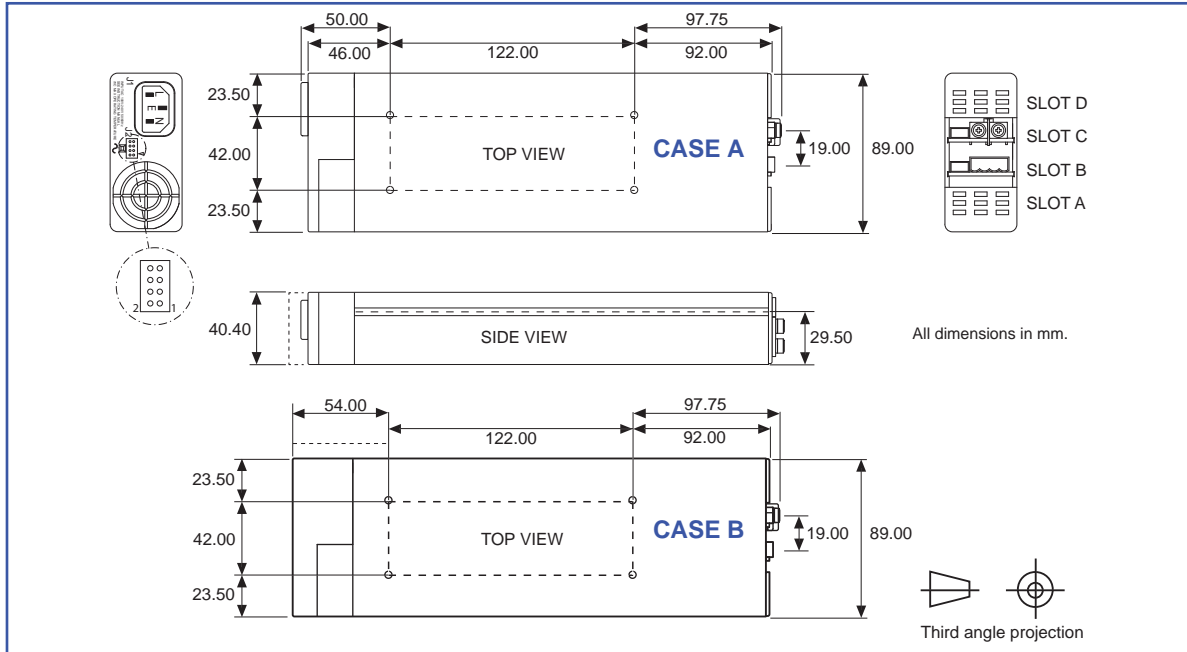

Medistax® - low noise

MECHANICALS - 6-SLOT

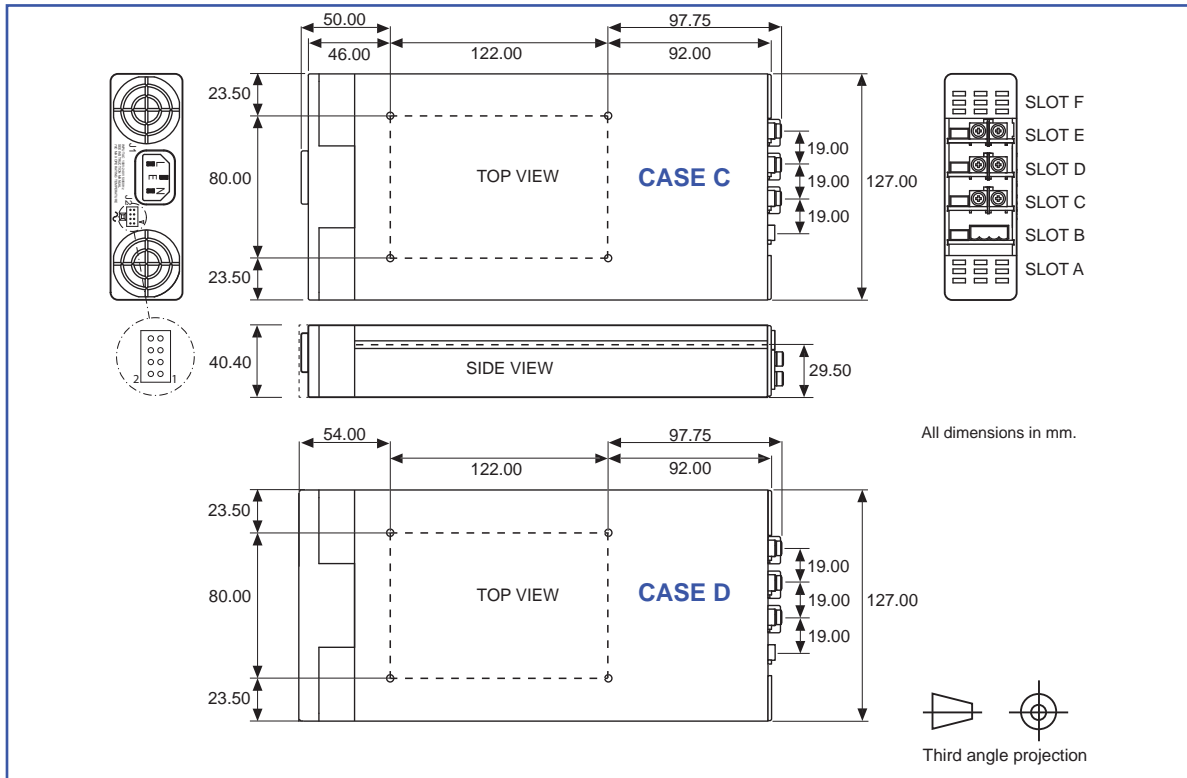

Mounting Holes
 4 x M4 threaded holes on Base.
 Max screw penetration is 6mm from Base.

Fleximount Side Mounting Slots
 Use with self-clinching PEM studs type FH-M4-X or FH-832-X (X= stud length) or equivalent

IEC to Screw Terminal Adaptor
 Order part number **MC1**

J2 Mating Connector
 Housing: Molex 51110-0860 - Locking
 Molex 51110-0850 - Non Locking
 Crimp Terminal: Molex 50394

J2 Pin Function	
1: Common	2: +5V Bias
3: -	4: AC Fail
5: Fan Fail*	6: Global Enable
7: Temp. Alarm*	8: Global Inhibit

* Option 1



DERATING CURVES - 4 SLOT

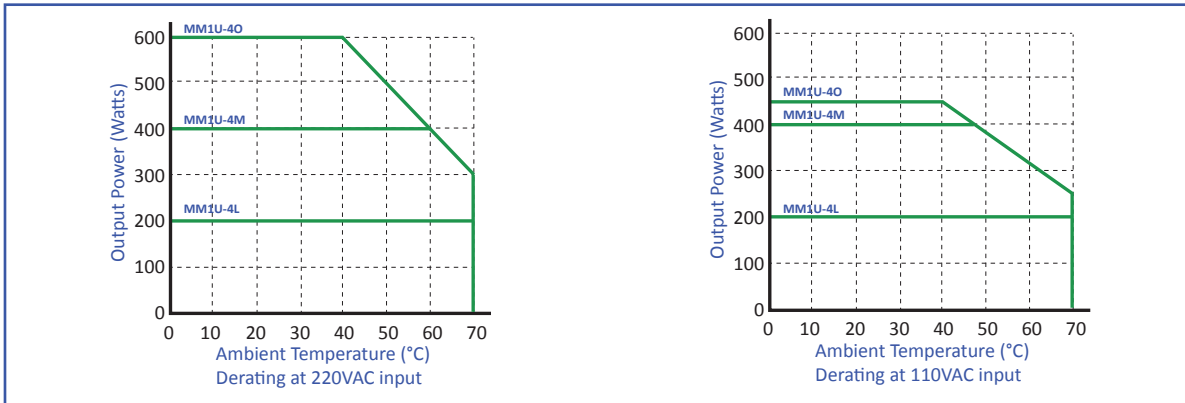

DERATING CURVES - 6 SLOT

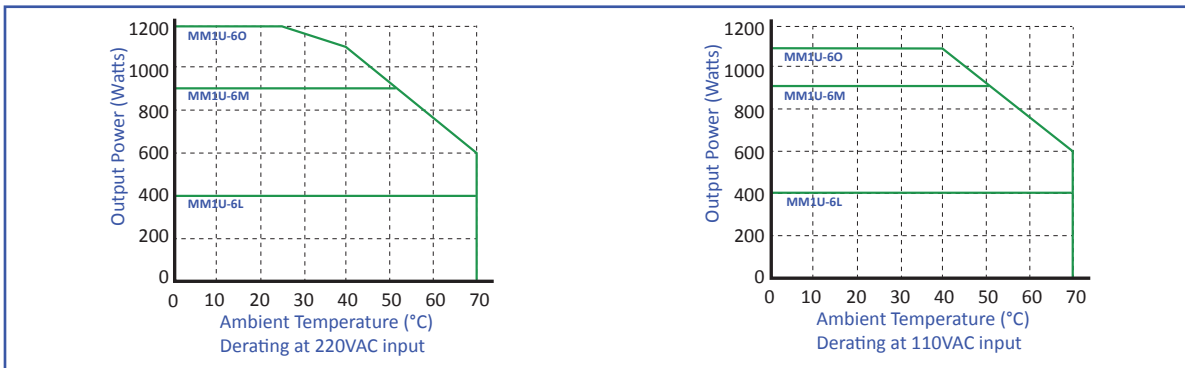

MODEL NUMBER CONFIGURATION GUIDE

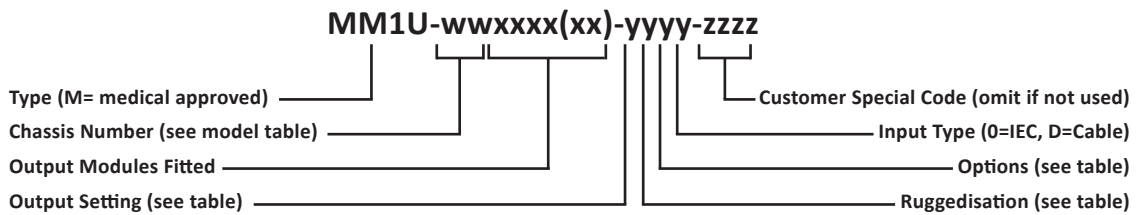

OUTPUT SETTING	
C	Custom Setting
-	Default Voltage

RUGGEDISATION	
C	Conformal Coating
R	Rugged
S	Conformal Coating & Rugged
0	No options

OPTIONS	
1	Thermal Signals
2	Reverse Fan
3	Thermal Signals & Reverse Fan
4	150µA Leakage
5	150µA Leakage + option 1
6	150µA Leakage + option 2
7	150µA Leakage + option 3
0	No options

Pre-set Units

Units are shipped with nominal output voltages unless pre-setting is specified.

Powerstax can pre-set units to exact customer requirements through use of appropriate parallel and series links as well as voltage adjustment to specific pre-set levels.

All specifications are typical at nominal line input, full load and 25°C unless otherwise stated.

Medistax® - low noise

Medistax-low_noise-ds-rev2-0414.indd

Powerstax Europe

Unit 5 Armstrong Mall
Southwood Business Park
Farnborough, Hampshire
GU14 0NR, UK

Powerstax North America

12804 W. Santa Ynez Drive
Sun City West
Arizona 85375
USA

Information and specifications contained in this data sheet are believed to be correct at the time of publication. However, Powerstax accept no responsibility for consequences arising from printing errors or inaccuracies. Specifications are subject to change without notice.