



PX-28515T-50 triple output High Reliability DC-DC Converters

- ❑ 0.38 Inch Profile
- ❑ Synchronization
- ❑ Remote Turn On (TTL)
- ❑ Output Voltage Trim Pin
- ❑ Built-in Test (Output Power OK)
- ❑ Over Voltage/ Over Current Protection
- ❑ Over Temperature Protection



DESCRIPTION:

The PX28515T-50 DC-DC converters, is DC-DC converter with small size and high reliability. It has triple outputs 5V and $\pm 15V$. The output power is 50 watts, and the switching frequency is fixed at 200KHz to minimize noise. Input to output isolation is accomplished via magnetic feedback. The typical input voltage is 28V. This input voltage ranges from 14V to 40V.

BLOCK DIAGRAM:

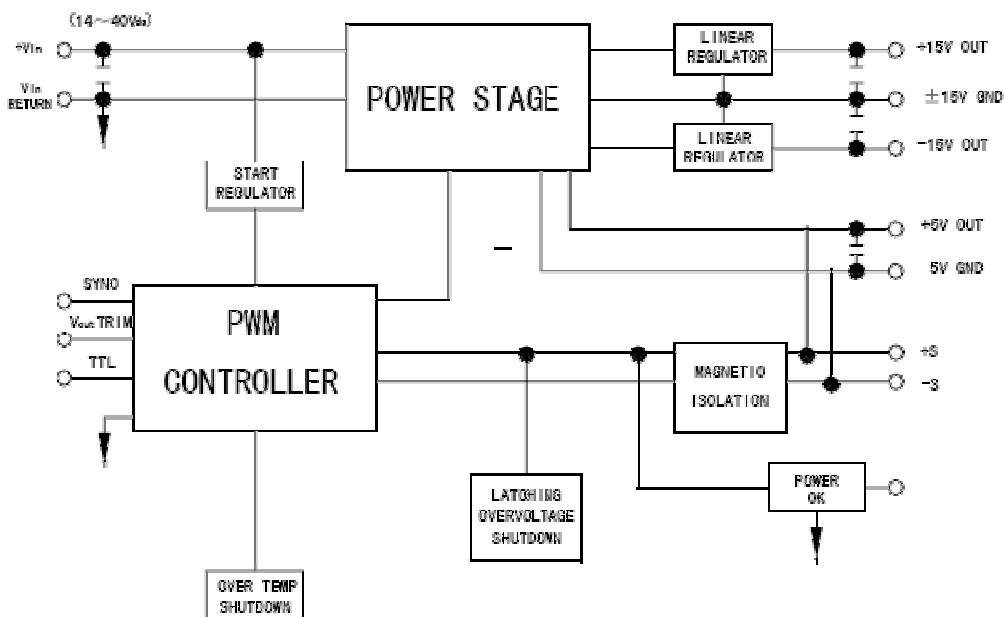



ABSOLUTE MAXIMUM RATINGS:

Input Voltage: +14V to +40V Storage Temp: -55°C to +125°C
 Power OK: 5.0V Pin-Solder Temp (10s): 300°C
 Output Over Current (max): 7.5A Operating Temp (Tc): -40°C to +75°C(I)/ -55°C to +100°C (M)

ELECTRICAL CHARACTERISTICS:

Input Characteristics							
	Min	Typ	Max	Units			
Input Voltage	14	28	40	V			
No Load Power Dissipation		3	5	W			
*Input Ripple Voltage		600	700	mVpp			
Efficiency (Full load)	64	68		%			
Output Characteristics							
	5V			±15V			Units
	Min	Typ	Max	Min	Typ	Max	Units
Output Current	0.5	5			0.83		A
Set Point Accuracy		1	2		1	2	%Vout
Load Regulation		0.1	0.5		0.2	1	%Vout
Line Regulation		0.1	0.5		0.2	1	%Vout
Ripple Voltage(20MHz)		75	150		50	150	mVpp
Trim Range	100		115				%Vout
Remote Sense Compensation		0.5					Vdc
Over Voltage Protection	120		125				%Vout
Transient Response							
*20 to 80% Load		500/200			200/30		µs/mV
*Low Line to High Line		750/250			500/50		µs/mV
*50 to 100% Load		500/200			200/30		µs/mV
Temperature Drift		0.005	0.015		0.01	0.025	%/°C
Current Limit	105	125	150	105	125	150	%Iout
Short Circuit Current	25		80	25		80	%Iout
Turn On Time		1.0			1.0		Ms
Logic Turn On Time		1.0			1.0		Ms
Over Temp Shut Down	110±5						°C
Thermal Resistance Case-Ambient	5						°C/W
Insulation Characteristics							
Insulation Resistance	≥100MΩ@100Vdc (input to output, any pins to case)						
Dielectric Strength	500Vdc						
Weight: ≤110g							



Performance Characteristics:

I. Output Voltage Ripple

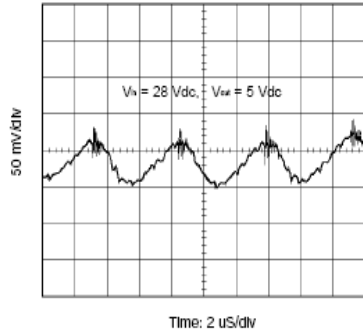

II. Efficiency vs. Output Power

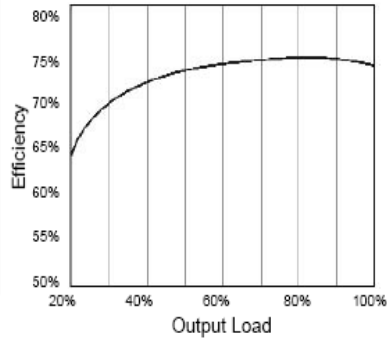

III. Efficiency vs. Input Voltage

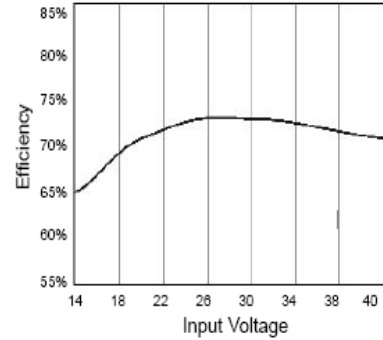

IV. Input Inrush Current

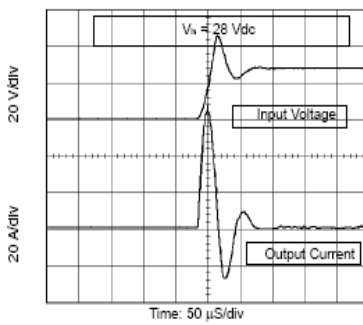

V. Load Transient Response

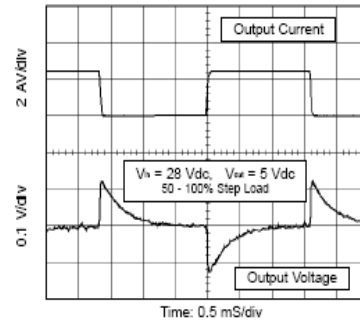

VI. Input Transient Response

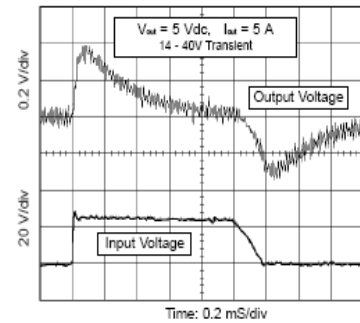

VII. Turn On

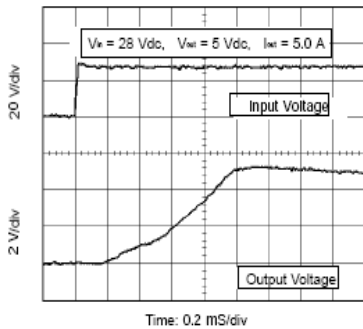

VIII. Input Current Ripple

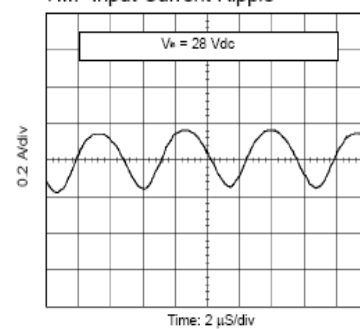

IX. TTL Turn On

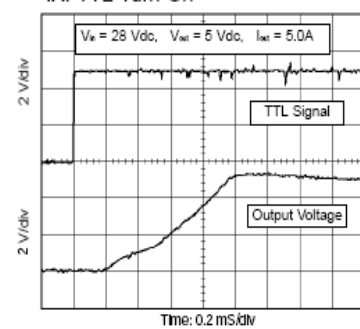

TYPE CONNECTED FIGURE

1 LOAD CONNECTED FIGURE

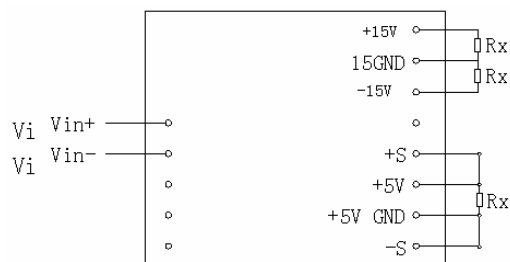

2 TTL PIN CONNECTED FIGURE

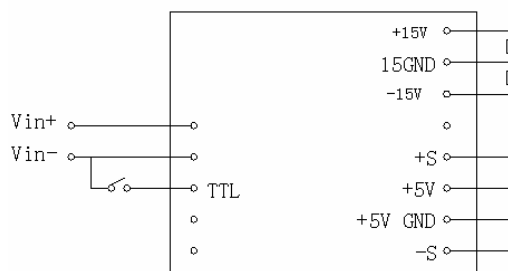

3 OUTPUT VOLTAGE TRIMMING PIN CONNECTED FIGURE

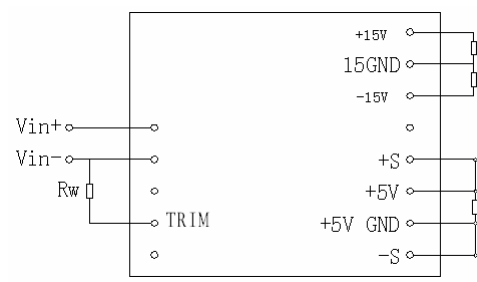

Application Notes:

TTL(Remote on/off)

The TTL pin is used to command the PX-28515T-50 on or off and is referenced to the input return. When the TTL pin is left unconnected, the converter will remain on. When the TTL pin is pulled down below 0.8V the unit will be turned off.

Power OK/Built-in-test

A power ok signal is provided to monitor the output voltage. The power ok is set at +5V (referenced to the input return). If the output voltage of the converter drops to below 90% of its normal set point (ie: out of regulation), the power ok pin is actively pulled low by a voltage comparator.

Over Temperature Protection

An integral electronic over temperature shut down circuit is provided to protect the PX-28515T-50 from accidental over heating. If the temperature (case temperature) of the converter exceeds the over temperature point ($110 \pm 5 \text{ }^\circ\text{C}$), the unit will automatically be shut down. Once the temperature (case temperature) is reduced to 10°C below $T_{c(ot)}$ (the case temperature of over temperature ?), power will be automatically restored.

Output Voltage Sensing

Output voltage sensing is provided for either local (at the unit) or remote (at the load) sensing. The sensing feature can automatically compensate for a 0.5V drop in voltage between the leads and the load. The sense pins must be connected (either locally or remotely) for normal operation. ie. -sense to -output and +sense to +output. (shown in figure)

Switching Frequency Synchronization

The switching frequency is set at 200KHz. The synchronization clock will be at twice the switching frequency (400KHZ). If required several units may be synchronized to the same switching frequency, connect all the sync pins together and all input returns of the unit together respectively.

Output Voltage Trimming

An output voltage trimming pin is provided for the adjustment of the output voltage. Using this feature the output voltage can be trimmed up to 115% (trimming is only available to increase the output voltage) of nominal value. To increase the output voltage, simply connect a resistor between the trimming pin and input return of the unit.

The value of the resistor required is determined by using the equation below,

$$R = (139K - 20V_{out}) / (V_{out} - 5)$$

As there is little variance between modules this resistor can be adjusted slightly to an optimum value.

Over current/Short Circuit Protection

The output of the PX-28515T-50 is protected from an accidental short circuit condition of any duration. When the output current exceeds the full load capability of the supply (from 105% to 150% of the maximum rated output current), the converter switches into a "Hiccup-Mode", when the over load/short circuit is removed, the converter automatically returns to its normal mode of operation.

Over Voltage Protection

The PX-28515T-50 provides an internal "Latching" over voltage protection circuit. When an over voltage condition occurs, the converter will be off.

NOTE:

- 1 It is recommended that capacitors be used in the input and output lines, to reduce input ripple voltage add a ceramic capacitor (low ESR) between the input pin and the input return.
- 2 When you are using the DC-DC module, on/Empty load of 5V, ±15V are prohibited.
- 3 ±S pin and +5V,+5VGND pins must be connected to avoid module failure.
- 4 When the DC-DC module is operating, you need to add a cooling fin.

ORDERING INFORMATION:

PX S 28 12 S - 30 T I A

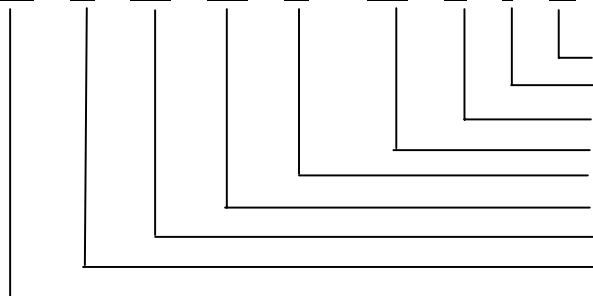

Modified
Grade – M = MIL, H + High Rel, I = Industrial
Case Style – Blank = standard case, T = With tabs.
Watts = e.g. 15, 30 etc.
Number of outputs S = Single, D = Dual, T = Triple
Output voltage
Nom Input Voltage – 12, 24 etc
Blank=No seal, H = Hermetically, S = Stannic Seam
Series Name

Mark specification:

Serials Number: DC 0621 001, which indicates this product has been manufactured in the 21st week of 2006, and the sequence number is 001.

Environmental Screening

Environmental Screening		
Environmental Stress Screening (ESS)		MIL-STD-2164
Burn-in	$T_C=100^{\circ}\text{C}$, 168h	
Electrical Test	-55°C , $+25^{\circ}\text{C}$, $+100^{\circ}\text{C}$ (T_C)	
Environment		
Depression (Altitude)	12kPa(12000m)	MIL-STD-810
Temperature Shock	-55°C to 125°C , 3 cycles	MIL-STD-810
Humidity	40°C , 93%RH, 6 days	
Vibration	$0.04\text{g}^2/\text{Hz}$, 5min	MIL-STD-810
Shock	500m/s^2 , 11ms, 3 times	MIL-STD-810
Acceleration	500m/s^2 , 5min	MIL-STD-810

MECHANICAL SPECIFICATIONS:

