



PXH-28XXD-15 Dual Output Series High Reliability DC-DC Converters

- ❑ High reliability, small size
- ❑ In photoelectric isolation
- ❑ Input Voltage range: 16VDC~40VDC
- ❑ Output Power: 15W
- ❑ Inhibit and synchronization functions
- ❑ Over current /short circuit protection
- ❑ DIP hermetical



DESCRIPTION:

The PXH-28XXS-30 single output series module adopts Thick-Film Microcircuit Technology, parallel seam welding process and is a high reliability converter suitable for use in applications in the aviation, aerospace and military sectors. The output voltages is $\pm 12V$ or $\pm 15V$. The output power is 15W. The switching frequency is fixed at 265 KHz to minimize noise. The input filter circuit is designed to reduce the electro-magnetic interference. The typical input voltage is 28V, and the ranges from 16V to 40V. The PXH-28XXD-15 series also provides some control functions such as synchronization, shut down, and over-current and short circuit protection.

BLOCK DIAGRAM:

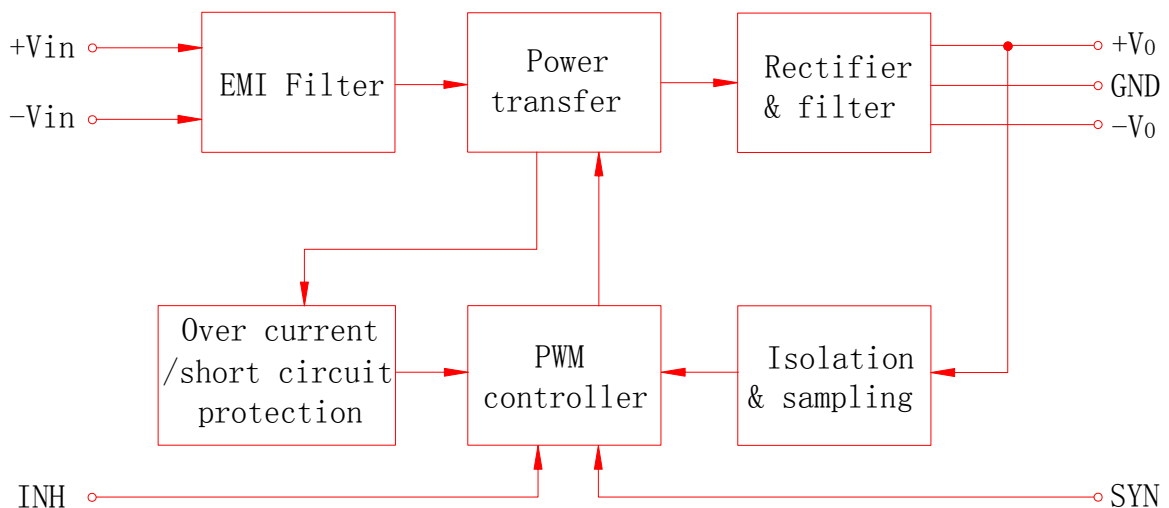

PXH-28XXD-15 Dual Output Series High Reliability DC-DC Converters



ABSOLUTE MAXIMUM RATINGS:

Input Voltage:	16V _{DC} to 40V _{DC}	Output Power:	15W
Operating Temp(T _C):	-55°C to +105°C(M)/ -40°C to +85°C(E)		
Storage Temp:	-65°C to +150°C (M) / -55°C to +125°C (E)		
Pin-Solder Temp (10S):	300°C		

ELECTRICAL CHARACTERISTICS:

PARAMETER	CONDITIONS ⁵	PXH-2812D-15			PXH-2815D-15			UNITS
		MIN MAX	TYP		MIN MAX	TYP		
OUTPUT VOLTAGE	V _{IN} =16V _{DC} ~40V _{DC}	11.88	12.00	12.12	14.85	15.00	15.15	V
	-V _o	11.82	12.00	12.18	14.77	15.00	15.23	
OUTPUT CURRENT	V _{IN} =28V _{DC} ±I _o	0	—	0.625	0	—	0.5	A
OUTPUT POWER	V _{IN} =28V _{DC}	0	—	15	0	—	15	W
OUTPUT RIPPLE VOLTAGE ¹	V _{IN} =28V, FULL LOAD, 20MHz	—	30	80	—	25	80	MVpp
	MIN~MAX T _C	—	40	120	—	40	120	
LINE REGULATION	V _{IN} =16V _{DC} ~40V _{DC}	—	10	50	—	10	50	MV
	MIN~MAX T _C	—	50	150	—	50	180	
LOAD REGULATION	V _{IN} =28V _{DC}	—	15	50	—	15	50	MV
	MIN~MAX T _C	—	30	150	—	30	180	
CROSS REGULATION	20%~80% ²	—	4	8.3	—	3	8	%
	10%~50% ³	—	4	6	—	4	6	
INPUT VOLTAGE	CONTINUOUS	16	28	40	16	28	40	V _{DC}
	TRANSIENT 50ms	0	—	50	0	—	50	
INPUT CURRENT	NO LOAD	—	50	75	—	50	75	mA
	FULL LOAD	—	0.88	—	—	0.86	—	A
	INHIBITED	—	7	8	—	7	8	mA
INPUT RIPPLE CURRENT	V _{IN} =28V, FULL LOAD, 20MHz	—	20	50	—	20	50	MApp
EFFICIENCY		79	81	—	80	83	—	%
LOAD FAULT SHORT CIRCUIT TO FULL LOAD	SHORT CIRCUIT POWER DISSIPATION	—	—	12	—	—	12	W
	RECOVERY ⁴	—	1.4	5.0	—	1.4	5.0	Ms
STEP LOAD RESPONSE. TRANSIENT	50%~100%~50%	—	±150	±300	—	±200	±400	MV
STEP LOAD RESPONSE. TRANSIENT RECOVERY		—	100	200	—	100	200	Us
STEP LINE RESPONSE. TRANSIENT	16-40-16V _{DC} ⁴	—	±200	±400	—	±400	±500	MV
STEP LINE RESPONSE. TRANSIENT RECOVERY		—	—	300	—	—	300	Ms
START-UP	DELAY	—	1.4	5	—	1.4	5	Ms
	FULL LOAD OVERSHOOT	—	0	120	—	0	150	MVpk
	NO LOAD OVERSHOOT	—	120	600	—	150	750	
Insulation Resistance	≥100MΩ @ 500VDC (input-output; any pins to case)							

NOTE:

- Using tip and barrel measurement.
- +Pout 20%~80%; -Pout 80%~20%.
- +Pout 50%; -Pout 10%~50%.
- Recovery time is measured from application of the transient to the point at which Vout is within 1% of final value.
- Unless otherwise specified, T_C =25°C V_{in} =28VDC 100% load.



Typical Performance Curves:

1: Output Ripple Voltage

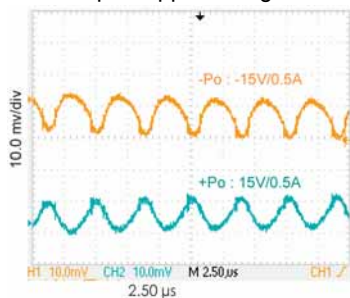

2: Start - Up

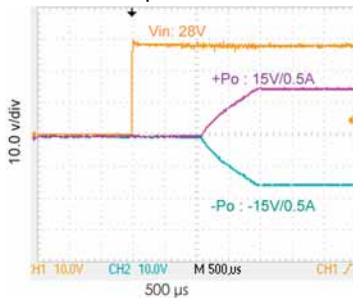

3: Efficiency

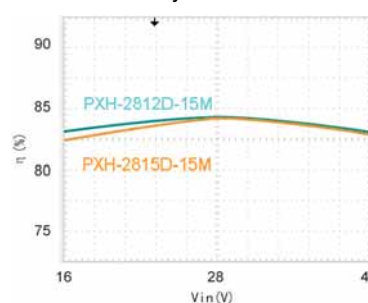

4: Step load Response

50%~100%~50%

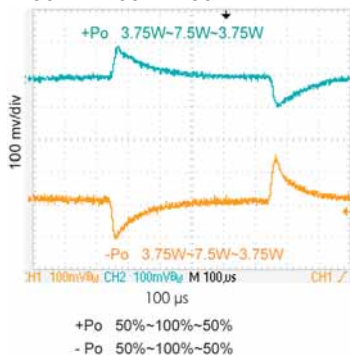

5: Efficiency

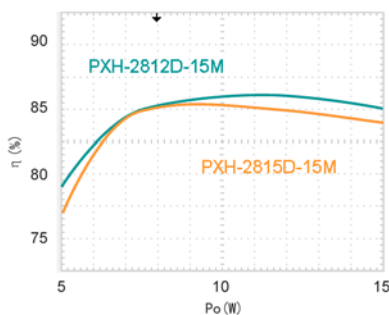

Application Notes:

INHIBIT FUNCTION

The INH pin is used to achieve the function of external shut down. No connection to Pin 2 is necessary for normal operation of the converter. Shut down may be implemented by simply pulling the Pin 2 below 0.3V referenced to input common.

Over Current/Short Circuit Protection

The PXH-28XXD-15 series of DC/DC converters has the function of over current/short circuit protection. When it is working under load fault condition, the converter will automatically activate the over current/short circuit protection and restore when the fault is removed. It is suggested that the duration of the over current/short circuit must be less than 10s, and the case temperature lower than 105°C, Otherwise, the module will be disabled.

Ripple Voltage

If the output V-ripple is too high for the application, it can be further suppressed by adding a filter capacitor between the Vo+ and Vo- outputs. The optimal value for this capacitor is recommended at around 50V/ 10µF with film or ceramic capacitor as preferable options.

Synchronization

The PXH-28XXD-15 series of DC/DC converters allow the designer to match the switching frequency of the converter to the frequency of the system clock or synchronize several modules by synchronization pin. Frequency ranges from 270 to 350 KHz, the level from -0.3 to 10V, and duty cycle from 40% to 60%. Under master and slave configuration, the master module will offer $\pm 3\text{mA}$ current and the slave ones $\pm 0.5\text{mA}$ in maximum.

Reverse Polarity Protection:

To avoid reverse input connection, it is advisable to connect a diode in series with the input pin of the converter. (Shown as below)

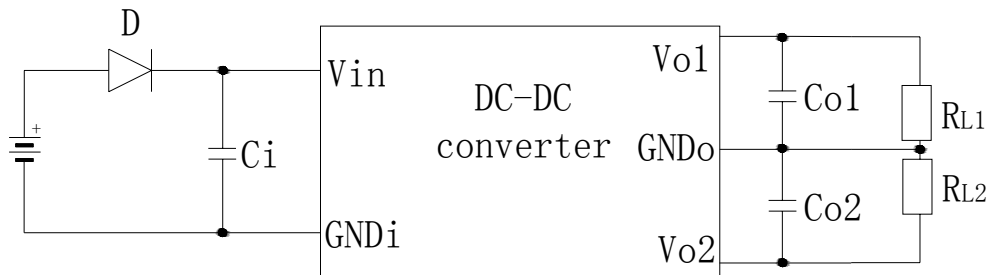

ORDERING INFORMATION:

PX S 28 12 S - 30 T I A

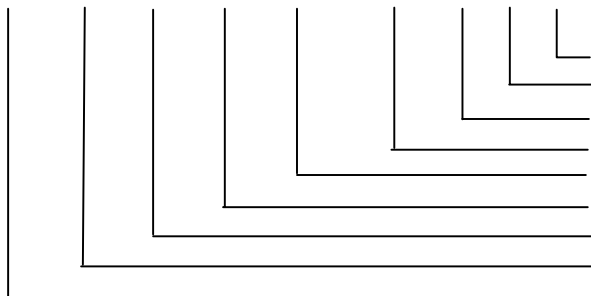

Modified
Grade – M = MIL, H + High Rel, I = Industrial
Case Style – Blank = standard case, T = With tabs.
Watts = e.g. 15, 30 etc.
Number of outputs S = Single, D = Dual, T = Triple
Output voltage
Nom Input Voltage – 12, 24 etc
Blank=No seal, H = Hermetically, S = Stannic Seam
Series Name

Mark specification:

Serials Number: DC 0621 001, which indicates this product has been manufactured in the 21st week of 2006, and the sequence number is 001.

Environmental Screening

Test items	Methods	Request	Conditions
PRE-CAP Inspection	MIL-STD-883 Method 2017	100%	---
Temp-Cycle	MIL-STD-883 Method 1010	100%	-65°C to+ 150°C(M), 10 times -55°C to +125°C(E), 10 times
Constant Acceleration	MIL-STD-883 Method 2001	100%	3000 g, Y1, 1min
Burn-in	MIL-STD-883 Method 1015	100%	Tc +105°C(M)/ +85°C(E), 160h
Final Electrical Test	MIL-PRF-38534	100%	-55°C, +25°C, +105°C(M) -40°C, +25°C, +85°C(E)
Hermetic Testing	MIL-STD-883 Method 1014	100%	Fine Leak, Cond. A1 Gross Leak, Cond. C1
Final Visual Inspection	MIL-STD-883 Method 2009	100%	---

PXH-28XXD-15 Dual Output Series High Reliability DC-DC Converters



MECHANICAL SPECIFICATIONS:

Weight: $\leq 56g$

Volume: 15.1cm³

Encapsulation: Seam Seal

Shell Material: Cold Rolled Steel

Package style: Two kinds of form (Standard and Tabbed) for customers to choose

Standard Case:

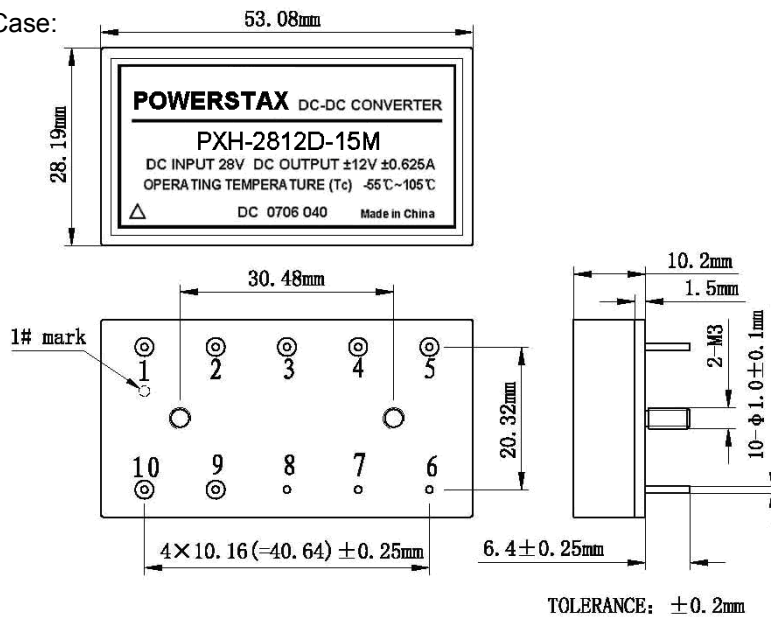

T (Tabbed) Case:

