



# PXH-28XXS-20 Single Output Series High Reliability DC-DC Converters

- ❑ High reliability, small size
- ❑ Input Voltage range: 16VDC to 40VDC
- ❑ Output Power: 15 - 20W
- ❑ Inhibit and synchronization functions
- ❑ In Photoelectric Isolation
- ❑ Over current /short circuit protection
- ❑ DIP hermetical



## DESCRIPTION:

The PXH-28XXS-20 single output series module adopts Thick-Film Microcircuit Technology, parallel seam welding process and is a high reliability converter suitable for use in applications in the aviation/aerospace and military sectors. The output voltage is 5V, 12V or 15V. The output power ranges from 15 to 20W. The switching frequency is fixed at 265 KHz to minimize noise. The input filter circuit is designed to reduce the electro-magnetic interference. The typical input voltage is 28V, and the ranges from 16V to 40V. The PXH-28XXS-20 series also provides some control functions such as synchronization, shut down, and over-current and short circuit protection.

## BLOCK DIAGRAM:

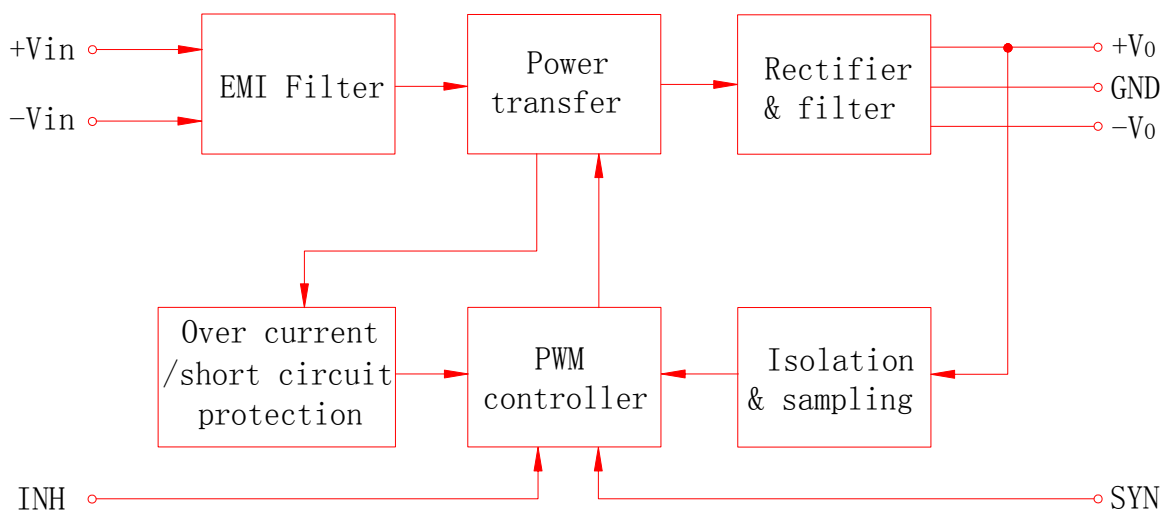

## PXH-28XXS-20 Single Output Series High Reliability DC-DC Converters



### ABSOLUTE MAXIMUM RATINGS:

Input Voltage: 16V<sub>DC</sub> to 40V<sub>DC</sub>

Output Power: 15 - 20W

Storage Temperature range (T<sub>c</sub>): -65°C to +150°C(M)/ -55°C to +125°C(E)

Operating Temperature (T<sub>c</sub>): -55°C to +105°C(M)/ -40°C to +85°C(E)

Pin-Solder Temperature (10S): 300°C

### ELECTRICAL CHARACTERISTICS:

PARAMETER	CONDITIONS <sup>3</sup>	PXS-2805S-15			PXS-2812S-20			PXS-2815S-20			UNITS
		MIN	TYP	MAX	MIN	TYP	MAX	MIN	TYP	MAX	
OUTPUT VOLTAGE	V <sub>IN</sub> =16 V <sub>DC</sub> to 40V <sub>DC</sub>	4.95	5.00	5.05	11.88	12.00	12.12	14.85	15.00	15.15	V <sub>DC</sub>
OUTPUT CURRENT	V <sub>IN</sub> =28V <sub>DC</sub>	0	—	3	0	—	1.67	0	—	1.33	A
OUTPUT POWER	V <sub>IN</sub> =28V <sub>DC</sub>	0	—	15	0	—	20	0	—	20	W
OUTPUT RIPPLE VOLTAGE <sup>1</sup>	V <sub>IN</sub> =28V FULL LOAD 20MHz	—	35	50	—	25	50	—	25	50	m V <sub>P-P</sub>
	MIN~MAX T <sub>c</sub>	—	50	90	—	40	90	—	40	90	
LINE REGULATION	V <sub>IN</sub> =16 to 40V <sub>DC</sub>	—	10	50	—	10	50	—	10	50	mV
	MIN~MAX T <sub>c</sub>	—	15	50	—	15	50	—	15	50	
LOAD REGULATION	NO LOAD TO FULL	—	5	50	—	5	50	—	5	50	mV
	MIN~MAX T <sub>c</sub>	—	15	50	—	15	50	—	15	50	
INPUT VOLTAGE	CONTINUOUS	16	28	40	16	28	40	16	28	40	V <sub>DC</sub>
	TRANSIENT 50ms	—	—	50	—	—	50	—	—	50	
INPUT CURRENT	NO LOAD	—	35	75	—	35	75	—	35	75	m A
	FULL LOAD	—	0.70	—	—	0.87	—	—	0.85	—	A
	INHIBITED	—	7	8	—	7	8	—	7	8	mA
INPUT RIPPLE CURRENT	V <sub>IN</sub> =28V FULL LOAD 20MHz	—	20	50	—	20	50	—	20	50	mApp
EFFICIENCY		76	78	—	80	83	—	81	84	—	%
LOAD FAULT SHORT CIRCUIT TO FULL LOAD	SHORT CIRCUIT POWER DISSIPATION	—	—	12	—	—	12	—	—	12	W
	RECOVERY	—	1.4	5	—	1.4	5	—	1.4	5	ms
STEP LOAD RESPONSE, TRANSIENT	50%-100%-50%	—	±200	±300	—	±250	±400	—	±350	±500	mV
		—	60	200	—	60	200	—	60	200	us
STEP LINE RESPONSE.	16-40-16V <sub>DC</sub>	—	±200	±300	—	±400	±500	—	±500	±600	mV
	RECOVERY <sup>2</sup>	—	—	300	—	—	300	—	—	300	us
START-UP	DELAY	—	1.4	5	—	1.4	5	—	1.4	5	ms
	FULL LOAD OVERSHOOT	—	0	50	—	0	120	—	0	150	mVpk
	NO LOAD OVERSHOOT	—	50	250	—	120	600	—	150	750	
Insulation Resistance	≥100MΩ @500VDC ( input-output, any pins to-case )										



## PXH-28XXS-20 Single Output Series High Reliability DC-DC Converters



### NOTE:

1. Using tip and barrel measurement.
2. Recovery time is measured from application of the transient to the point at which Vout is within 1% of final value.
3. Unless otherwise specified, Tc=25°C, Vin=28Vdc, 100% load,

## Typical Performance Curves:

1: Output Ripple Voltage

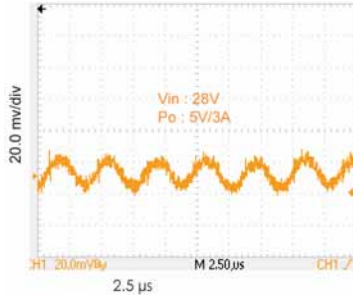

2: Start-Up

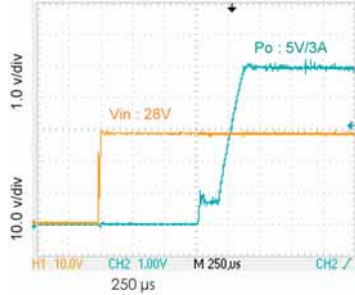

3: Efficiency

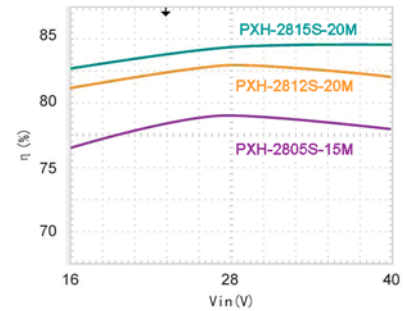

4: Step load Response

50% ~ 100% ~ 50%



5: Efficiency

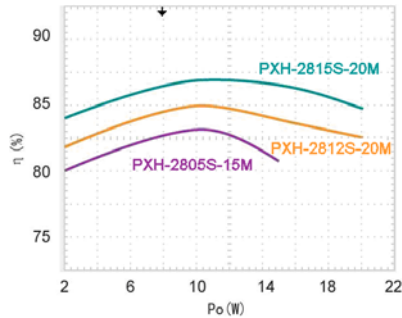

## Application Notes:

### INHIBIT FUNCTION

The INH pin is used to achieve the function of external shut down. No connection to Pin 2 is necessary for normal operation of the converter. Shut down may be implemented by simply pulling the Pin 2 below 0.3V referenced to input common.

### Over Current/Short Circuit Protection

The PXH-28XXS-20 series of DC-DC converters has the function of over current/short circuit protection. When it is working under load fault condition, the converter will automatically activate the over current/short circuit protection and restore when the fault is removed. It is suggested that the duration of the current/short must be less than 10s, and the case temperature lower than 105°C. Otherwise, the module will be disabled.

### Ripple Voltage

If the output V-ripple is too high for the application, it can be further suppressed by adding a filter capacitor between the Vo+ and Vo- outputs. The optimal value for this capacitor is recommended at around 50V/ 10μF with film or ceramic capacitor as preferable options.



**Synchronization**

The PXH-28XXD-30 series of DC-DC converters allows the designer to match the switching frequency of the converter to the frequency of the system clock or synchronize several modules by synchronization pin. Frequency ranges from 260 to 350 KHz, the level from -0.3 V to 10V, and duty cycle from 40% to 60%. Under master and slave configuration, the master module will offer  $\pm 3\text{mA}$  current and the slave ones  $\pm 0.5\text{mA}$  in maximum.

**Reverse Polarity Protection:**

To avoid reverse input connection, it is advisable to connect a diode in series with the input pin of the converter. (Shown as below)

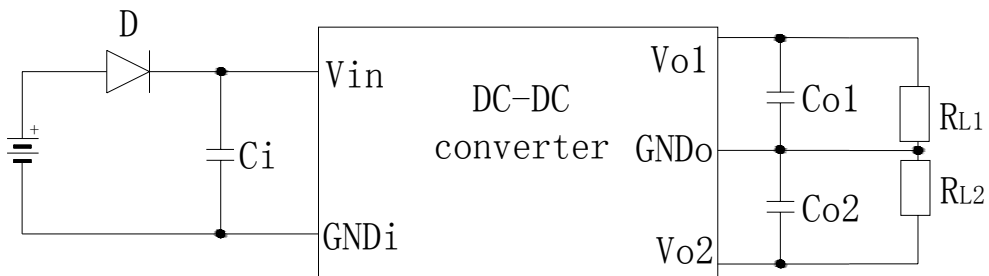

**ORDERING INFORMATION:**

**PX S 28 12 S - 30 T I A**

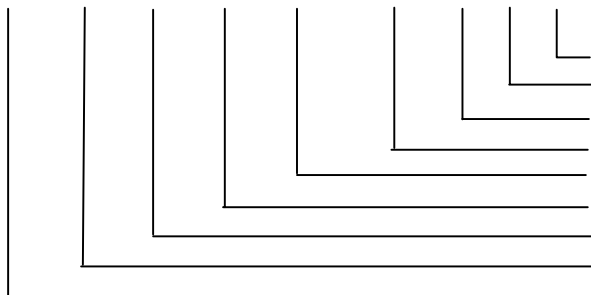

Modified  
Grade – M = MIL, H + High Rel, I = Industrial  
Case Style – Blank = standard case, T = With tabs.  
Watts = e.g. 15, 30 etc.  
Number of outputs S = Single, D = Dual, T = Triple  
Output voltage  
Nom Input Voltage – 12, 24 etc  
Blank=No seal, H = Hermetically, S = Stannic Seam  
Series Name

**Mark specification:**

Serials Number: DC 0621 001, which indicates this product has been manufactured in the 21st week of 2006, and the sequence number is 001.

**Environmental Screening**

Test items	Methods	Request	Conditions
PRE-CAP Inspection	MIL-STD-883 Method 2017	100%	---
Temp-Cycle	MIL-STD-883 Method 1010	100%	-65°C to+ 150°C(M), 10 times -55°C to +125°C(E), 10 times
Constant Acceleration	MIL-STD-883 Method 2001	100%	3000 g, Y1, 1min
Burn-in	MIL-STD-883 Method 1015	100%	Tc +105°C(M)/ +85°C(E), 160h
Final Electrical Test	MIL-PRF-38534	100%	-55°C, +25°C, +105°C(M) -40°C, +25°C, +85°C(E)
Hermetical Testing	MIL-STD-883 Method 1014	100%	Fine Leak, Cond. A1 Gross Leak, Cond. C1
Final Visual Inspection	MIL-STD-883 Method 2009	100%	---

**MECHANICAL SPECIFICATIONS:**

Weight:  $\leq 56g$

Volume: 15.1cm<sup>3</sup>

Encapsulation: Seam Seal

Shell Material: Cold Rolled Steel

Package style: Two kinds of form (Standard and Tabbed) for customers to choose

Standard Case:

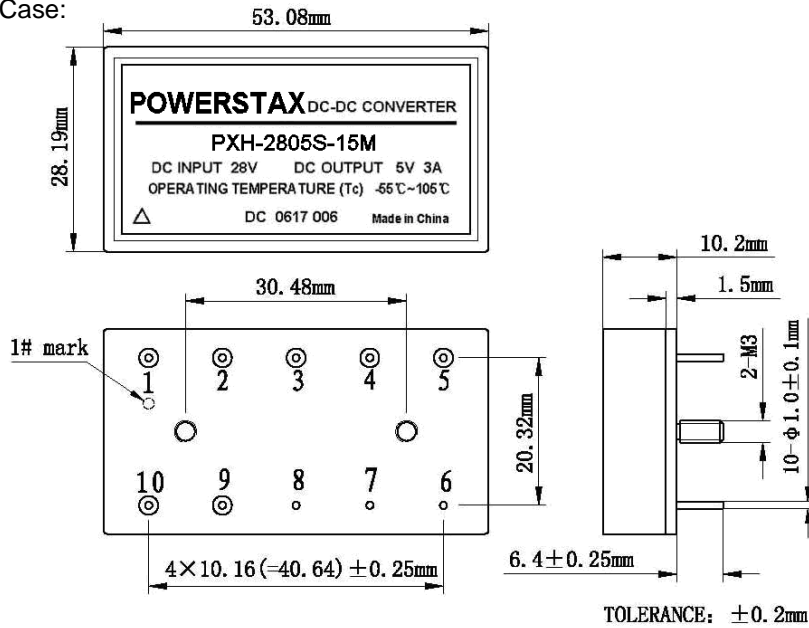

T (rabbed) case:

