



PXS-28XXD-30H Dual Output Series High Reliability DC-DC Converters

- ❑ High reliability, small size
- ❑ High power density: 31W/in³
- ❑ Input voltage range: 16VDC to 40VDC
- ❑ Output power: 30W
- ❑ Inhibit and synchronization functions
- ❑ Fully isolated
- ❑ In photoelectric isolation
- ❑ Output over current /short circuit protection
- ❑ DIP metal sealed



DESCRIPTION:

The dual output series module, which adopts Thick-Film microcircuit technology, is a kind of perfect converter with high reliability necessary for some applications such as industry and military. The output voltage is $\pm 12V$ or $\pm 15V$. The output power is 30W. The switching frequency is fixed at 265 KHz to minimize noise. The input filter circuit is designed to reduce the electro- magnetic interference. The typical input voltage is 28 VDC, and the ranges from 16 VDC to 40 VDC. The PXS-28XXD-30H series also provides some control functions such as synchronization, shut down, and over-current and short circuit protection.

BLOCK DIAGRAM:

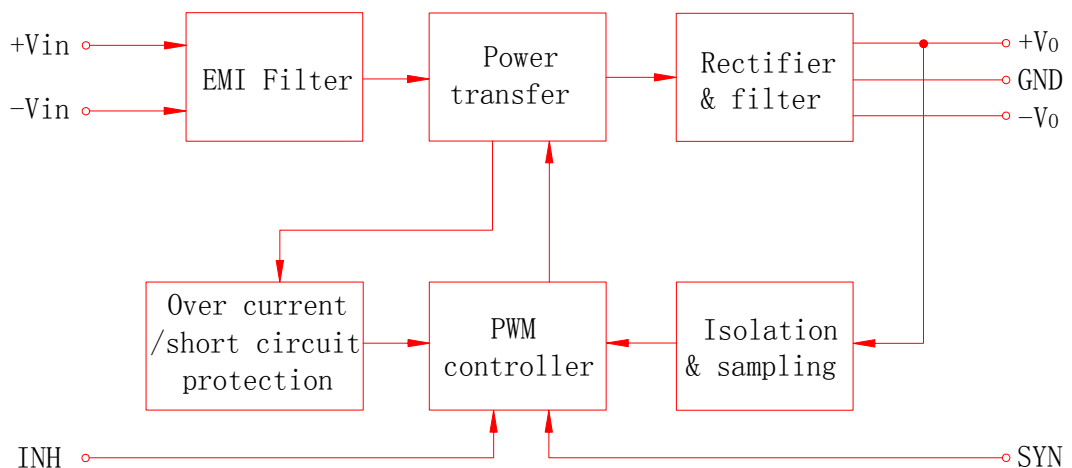

ABSOLUTE MAXIMUM RATINGS

Input Voltage:	16V _{DC} to 40V _{DC}	Output Power:	20 - 30W
Operating Temp(T _C):	-40°C to +85°C	Storage Temp:	-55 °C to +125 °C
Pin-Solder Temp (10S):	300 °C		

ELECTRICAL CHARACTERISTICS:

Parameter	Conditions	PXS2812D-30			PXS2815D-30			Units
		MIN	TYP	MAX	MIN	TYP	MAX	
Output voltage	V _{IN} =16V to 40V +V _o	11.88	12.00	12.12	14.85	15.00	15.15	V
	V _{IN} =16V to 40V -V _o	11.82	12.00	12.18	14.77	15.00	15.23	
Output current	V _{IN} =28V _{DC} ±I _o	0	-	1.25	0	-	1.0	A
Output power	V _{IN} =28V _{DC}	0	-	30	0	-	30	W
Output Ripple ¹ ±V _o	20MHz	-	30	80	-	25	80	mV _{pp}
	TCmin to TCmax	-	40	120	-	40	120	
Line Regulation	V _{IN} =16V to 40V +V _o	-	10	30	-	10	30	mV
	-V _o	-	50	120	-	50	150	
	TCmin to TCmax +V _o	-	10	50	-	10	50	
Load Regulation	Io=0 to 100% +V _o	-	15	30	-	15	30	mV
	-V _o	-	30	120	-	30	150	
	TCmin to TCmax +V _o	-	15	50	-	15	50	
Cross Regulation	20% to 80% ²	-	4	8.3	-	3	8	%
	10% to 50% ³	-	4	6	-	4	6	
Input voltage	continuous	16	28	40	16	28	40	V
	50V/50ms	0	-	50	0	-	50	
Input current	No load	-	50	75	-	50	75	mA
	Full load	-	1.34	-	-	1.29	-	A
	Inhibit	-	3	8	-	3	8	mA
Input ripple current ¹	20MHZ	-	20	50	-	20	50	mA _{p-p}
Efficiency		78	81	-	80	83	-	%
Short Circuit	dissipation	-	-	15	-	-	15	W
	recovery time ⁴	-	1.4	5.0	-	1.4	5.0	ms
Step Load Response±V _o	50% to 100% to 50%	-	±150	±300	-	±200	±400	mV
Step Load Recovery ⁴		-	100	200	-	100	200	µs
Step Line Response ±V _o	Overshoot	-	±200	±400	-	±400	±500	mV
	Recovery time ⁴	-	-	300	-	-	300	µs
Start up	delay	-	1.4	5	-	1.4	5	ms
	Overshoot (full)	-	0	120	-	0	150	mVpk
	Overshoot (no)	-	120	600	-	150	750	
Insulation Resistance	≥100MΩ@500VDC (input to output, any pins to case)							

NOTE:

- Using tip and barrel measurement.
- +Pout 20%~80%; -Pout 80%~20%.
- +Pout 50%; -Pout 10%~50%.
- Recovery time is measured from application of the transient to the point at which Vout is within 1% of final value.
- Tc =25 °C, Vin =28VDC, 100% load, unless otherwise specified.

Typical Performance Curves:

1: PXS-2815D-30H Ripple

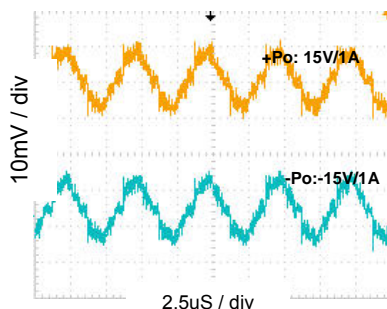

2: PXS-28XXD-30H Turn On

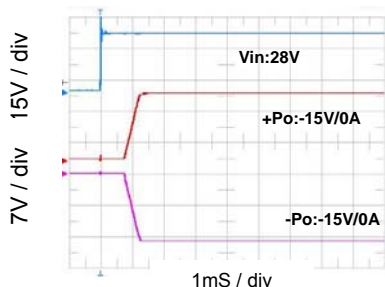

3: PXS-2815D-30H Load Step 50%~100

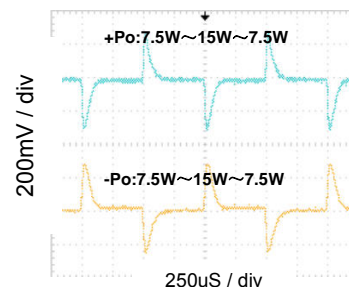

4: Efficiency

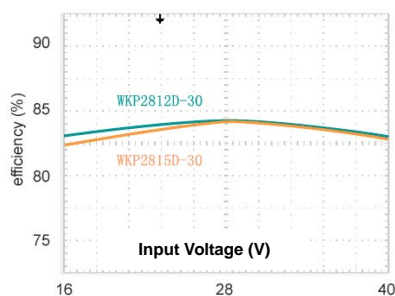

5: Efficiency

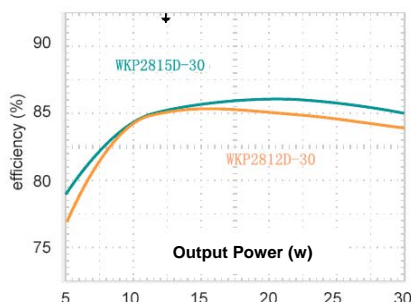

APPLICATION NOTES

INHIBIT FUNCTION

The INH pin is used to achieve the function of external shut down. No connection to Pin 2 is necessary for normal operation of the converter. Shut down may be implemented by simply pulling the Pin 2 below 0.3V referenced to input common.

Over Current/Short Circuit Protection

The PXS-28XXD-30H I series of DC/DC converters has the function of over current/short circuit protection. When it is working under load fault condition, the converter will automatically activate the over current/short circuit protection and restore when the fault is removed. It is suggested that the duration of the over current/short circuit must be less than 10s, and the case temperature lower than 105°C. Otherwise, the module will be disabled.

Ripple Voltage

If the output V-ripple is too high for the application, it can be further suppressed by adding a filter capacitor between the Vo+ and Vo- outputs. The optimal value for this capacitor is recommended at around 50V/ 10µF with film or ceramic capacitor as preferable options.

Synchronization

The PXS-28XXD-30H series of DC/DC converters allow the designer to match the switching frequency of the converter to the frequency of the system clock or synchronize several modules by synchronization pin. Frequency ranges from 270 to 350 KHz, the level from -0.3 to 10V, and duty cycle from 40% to 60%. Under master and slave configuration, the master module will offer ±3mA current and the slave ones ±0.5mA in maximum.

Reverse Polarity Protection:

To avoid reverse input connection, it is advisable to connect a diode in series with the input pin of the converter. (Shown as below)

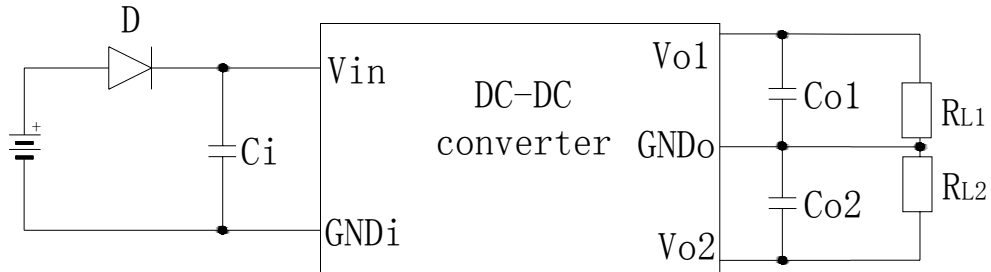

ORDERING INFORMATION:

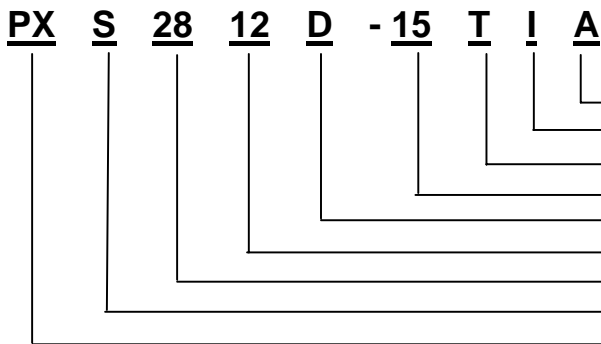

Modified
Grade – M = MIL, H + High Rel, I = Industrial
Case Style – Blank = standard case, T = With tabs.
Watts = e.g. 15, 30 etc.
Number of outputs S = Single, D = Dual, T = Triple
Output voltage
Nom Input Voltage – 12, 24 etc
Blank=No seal, H = Hermetically, S = Stannic Seam
Series Name

Mark specification:

Serials Number: DC 0621 001, which indicates this product has been manufactured in the 21st week of 2006, and the sequence number is 001.

Environmental Screening

Test item	Method	Condition	E	I
PRE-CAP Inspection	MIL-STD-883 Method 2017	---	Y	Y
Temp-Cycle	MIL-STD-883 Method 1010	-55°C to +125°C, 10 times	Y	---
Constant Acceleration	MIL-STD-883 Method 2001	500 g, Y1, 1min	Y	---
Burn-in	MIL-STD-883 Method 1015	+85°, 96h	Y	---
		+85°, 48h	---	Y
Final Electrical Test	MIL-PRF-38534	+25°	Y	Y
		+85°	Y	---
		-40°	Y	---
Final Visual Inspection	MIL-STD-883 Method 2009	---	Y	Y

